

CARILOHA 

# RETREAT COMFORT BASE™ USER'S MANUAL



# TABLE OF CONTENTS

INTRODUCTION .....	1	CHILD SAFETY LOCK .....	10
FEATURES .....	1	REMOTE ASSEMBLY AND FREQUENCY SETUP .....	11
IMPORTANT SAFETY INFORMATION .....	2	REMOTE CONTROL SYNCHRONIZING TWO ADJUSTABLE BASES .....	12
WEIGHT RESTRICTIONS AND EMERGENCY BACKUP .....	3	REMOTE CONTROL FEATURES .....	13
QUICK SET-UP GUIDE .....	4-5	VOICE CONTROL SETUP .....	14
GETTING STARTED .....	6	FAQ .....	15
POWER CORD SETUP .....	7	TROUBLESHOOTING GUIDE .....	16
JOINING TWO ADJUSTABLE BASES (WITH LEGS) .....	8	COMPONENT GUIDE .....	17
ZERO CLEARANCE BASE CONNECTION STEPS .....	9	10 YEAR LIMITED WARRANTY .....	18

## INTRODUCTION

Thank you for purchasing the Cariloha Retreat Comfort Base™. We're confident that you will enjoy your new Comfort Base adjustable bed for years to come. If you have any questions, please don't hesitate to contact our customer service team at 800-884-5815. Our goal is to provide you with an excellent product and superior service.

## FEATURES OF THE CARILOHA RETREAT COMFORT BASE ADJUSTABLE BED

- Head and foot up/down positions.
- Pillow tilt support.
- Head and foot massage with 10 minute auto shut-off.
- USB charging ports.
- 16 button wireless remote control.
- Bluetooth for phone remote application.
- Pre-programmed positions: anti-snore, zero gravity, and flat position.
- 2 programmable positions: I and II.
- Six legs with customizable heights, including zero clearance.
- Undercarriage is made with reinforced steel components for strength and durability.
- Emergency backup battery strip.
- Mattress foot retainer bar.
- Non-skid fabric.
- Offline voice control.

**Note:** This base is designed to fit within a standard bedframe.

# IMPORTANT SAFETY INFORMATION

PLEASE READ ALL INSTRUCTIONS AND SAFETY INFORMATION CAREFULLY BEFORE USE AND ASSEMBLY.

## SAFETY INFORMATION

Only use the adjustable bed base for its intended use as described in this manual. Follow the guidelines below for your safety, the safety of others and to avoid risk of electrical shock, fire, burns or injury:

- Avoid fingers in pinch-points.
- Two or more adults is strongly recommended for moving and assembling of the adjustable bed base.
- Plug adjustable bed base into a surge protector (not included) or directly into a suitable wall outlet.
- If the plug does not fit your outlet, contact a qualified electrician to install a suitable outlet. Unauthorized modification or failure to use a proper power source or surge protector will void the electrical portion of your warranty.
- Keep power cords away from heated surfaces.
- To safely disconnect, ensure the base is in a flat position with all motors off, and unplug from power source.
- Always unplug the base from the electrical outlet before cleaning or servicing.
- Discontinue use of the bed base and contact a qualified service center if: it has a damaged cord or plug, is not working properly, or has been dropped into water.
- Do not place the adjustable bed base or any of its components near or in water.
- Do not drop or insert objects into any opening. Never operate the base when there is an obstruction between the moving parts of the adjustable base and the metal frame.
- Replacing parts on the adjustable base is allowed to be done by consumer, however tampering with internal components will void the warranty.
- Do not use accessories/attachments that are not recommended by the manufacturer.

- Exceeding the weight restriction (see next page) could damage the bed and/or cause injury and will void the warranty.
- Do not operate the adjustable bed base when a person or animal is underneath the adjustable bed base.
- Mattresses may move or shift on bases – use caution.
- If the adjustable legs are utilized, all 6 legs must be installed and resting evenly on the floor.

**VIOLATING ANY OF THE SAFETY INFORMATION WILL VOID THE WARRANTY AND MAY RESULT IN INJURY OR DAMAGE TO FLOOR.**

### TIPPING WARNING

Placing weight at the edge may cause base to tip.

### IN-HOME USE

The adjustable base is designed solely for in-home use. This base was not designed as a hospital bed and is not designed to meet hospital standards. Do not use this base with tent type oxygen therapy equipment or near explosive gases.

### OPERATION AND SUPERVISION

Close supervision is required when the bed base is used by or near children, animals, convalescents or disabled persons. Immediately dispose of all packing materials as they may pose a risk to small children and pets. To avoid injury, do not allow children or small pets to play on or under the adjustable bed base.

### PACEMAKERS

As with any product that produces a vibrating motion, it is possible that some pacemakers may interpret this motion as a false sense of movement and/or exercise. This may or may not affect your pacemaker. If you have any concerns, please consult your physician.

## WEIGHT RESTRICTIONS

The recommended weight restriction for the adjustable base is 750 pounds, which is calculated to include the weight of the mattress. To calculate the weight limit, subtract the weight of the mattress from 750 pounds. The bed will support the recommended weight limits if distributed evenly across the base.

This product is not designed to support or lift the total maximum weight limit by the head or the foot section only. Consumers should not enter or exit the bed with any portion of the adjustable base in the raised position; always return the bed to a flat position prior. If the weight limit is exceeded on the head or foot mechanism, the master controller will stop all functions. Exceeding the recommended weight limit restrictions could damage the bed and void the warranty.

## OPERATING NOISES

The massage function emits a noticeable tone during operation. As the massage intensity level is increased, the tone will intensify. The noise will be less audible on a carpeted floor and a bit more noticeable when on a hard floor surface.

During typical operation, the wheels, which allow the bed to articulate, will make contact with the steel platform supports of the base creating a contact noise. When entering, exiting or shifting weight on the base, this contact noise may be audible as the wheels make contact with the steel platform supports of the base. This is normal. Depending on the incline of the base, the noise levels can also potentially increase.

## EMERGENCY BACKUP

In case of a power failure, the adjustable base features an emergency backup that allows you to return the bed to the flat position without power.

- Step 1:** Disconnect the adjustable base(s) from the power outlet.
- Step 2:** Locate the Emergency Battery Strip and install two 9-volt batteries.
- Step 3:** Attach the Emergency Battery Strip to the power cord.
- Step 4:** After the electricity is restored, the Emergency Battery Strip must be removed before plugging the adjustable base back into the power outlet.

**Warning:** Using the Emergency Battery Strip while the adjustable base is plugged into a power outlet may cause the electrical components to short out and damage the Master Control Box.

# QUICK SET-UP GUIDE

## STEP 1: POWER CORD SET UP

CAREFULLY open the adjustable bed base into an L position on its side or lay flat with the bottom facing up. This step may require two adults for safety.

Ensure all power cord connections circled to the right are completely plugged-in.

*Installation of the Backup Battery Pack is optional. Only put batteries into the Backup Battery Pack during an electrical outage and after the power cord is unplugged from a power source. Leaving in the 9 Volt batteries in the Emergency Battery Back Up Box after power has been restored will cause the electrical components to short out and damage the master controller.*

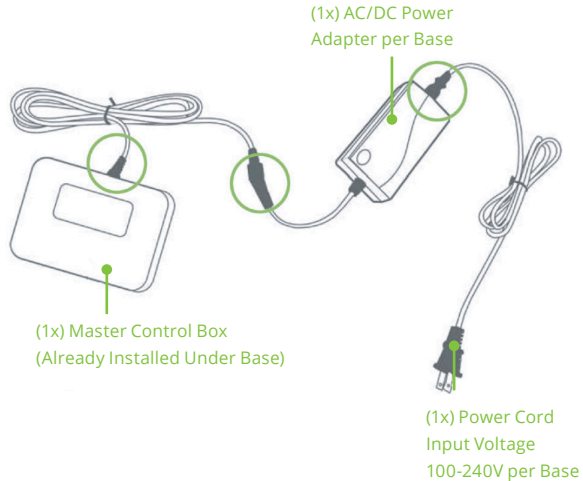

## STEP 2: (OPTIONAL) ASSEMBLE LEGS

Locate the legs and choose one of the heights. Make sure the leg with the solid end is touching the floor.

Screw six legs into the pre-drilled holes by hand. All legs must be installed and resting evenly on the floor.

The legs must not exceed 12"; anything taller is considered unstable.

*Violating any of the safety guidelines may result in damage or injury, void the warranty for improper use and may cause damage to the floor.*

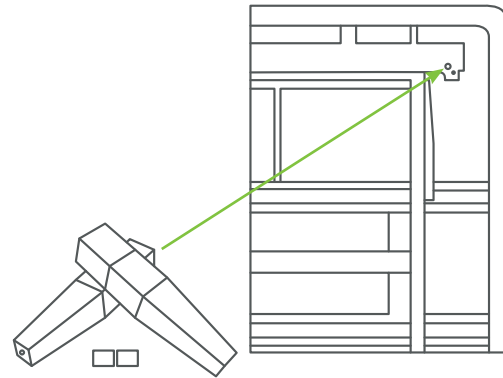

### STEP 3: INSTALL REMOTE BATTERIES

Locate the wireless remote control and insert (3x) AAA batteries (included). The remote control is pre-programmed to work with the adjustable bed base.

If you have more than one adjustable bed base, each remote control and adjustable bed base set should be pre-programmed to work separately. This will prevent both beds from being controlled by one wireless remote control.



### STEP 4: INSTALL MATTRESS RETAINER BAR

Slide the retainer bar into the opening at the foot of the bed.

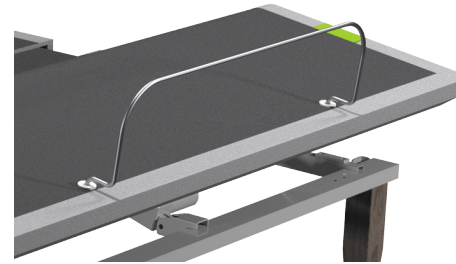

### STEP 5: RETURN TO UPRIGHT POSITION

If legs are utilized, CAREFULLY place the adjustable bed base onto all six legs and plug the power cord into a power outlet. Place a mattress on the adjustable base once the bed is plugged in and functioning correctly. Use a memory foam, latex or acceptable hybrid mattress at least 8" in height.

See manual for Connecting Strap and Sync cable instructions for Split King/Cal King Bases.

# GETTING STARTED

## NO TOOLS REQUIRED FOR ASSEMBLY

Use caution at pinch points and unfolding the base as parts may have shifted during shipping.



(1x) Wireless  
Back-Lit Remote  
(3x) AAA Batteries  
Included per Base



(6x) Three-Piece  
Adjustable Legs



(1x) Simultaneous  
Synchronization Cable  
(Only included with  
Twin XL/CKS bases)



(1x) Split Adj Base Sets  
Connecting Strap  
(Only included with  
Twin XL/CKS bases)

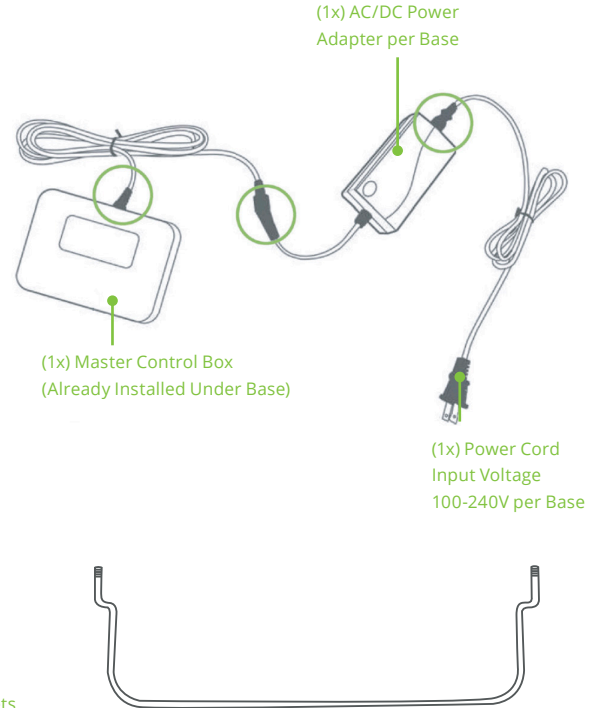

(1x) AC/DC Power  
Adapter per Base

(1x) Master Control Box  
(Already Installed Under Base)

(1x) Power Cord  
Input Voltage  
100-240V per Base



(1x) Foot Retainer Bar



# POWER CORD SETUP

CAREFULLY open the adjustable bed base into an L position on its side or lay flat with the bottom facing up. This step may require two adults for safety.

Ensure all power cord connections circled to the right are completely plugged-in.

Installation of the Backup Battery Pack is optional. Only put batteries into the Backup Battery Pack during an electrical outage and after the power cord is unplugged from a power source.

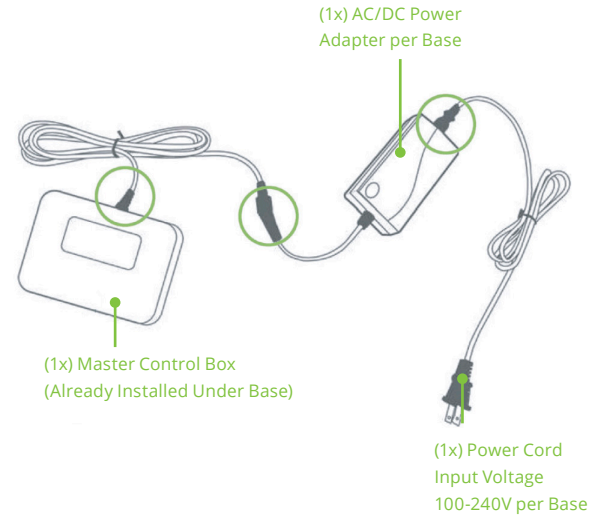

# JOINING TWO ADJUSTABLE BASES

If any split setup is being installed, plastic connecting straps are provided (one per base) to secure the bases together. Use both straps to secure the head and foot portions together.

With the bases in their desired location, slightly loosen both legs to allow the strap to fit on the leg bolt, between the leg washer and frame.

Slide side (A) of the connecting strap onto leg bolt. Swing the strap and connect side (B) to the leg bolt. Secure the strap by shifting to the left.

Re-tighten legs. Do not over tighten. Use the remaining strap and repeat on other end of the base.

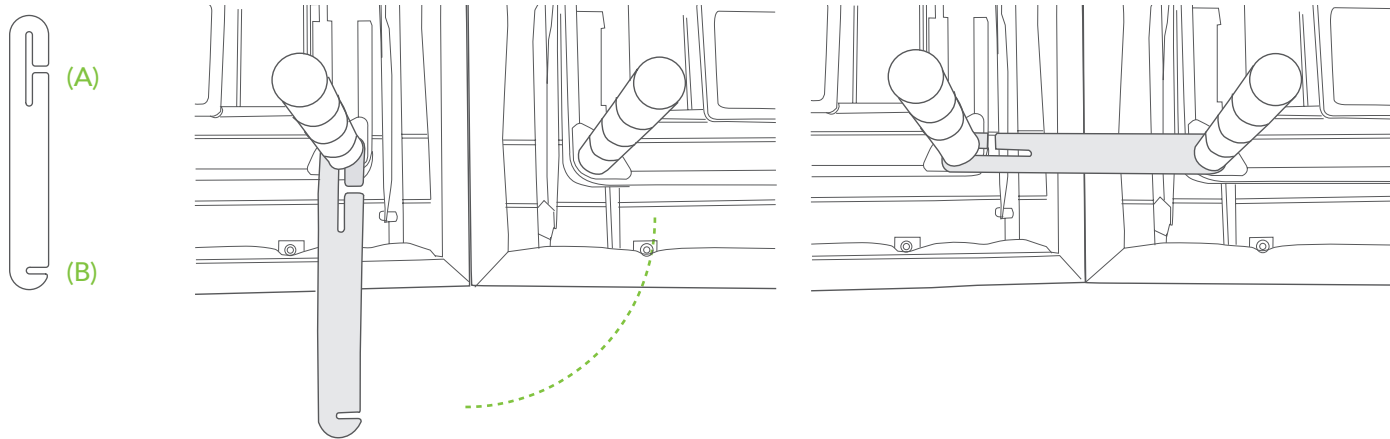

# ZERO CLEARANCE BASE CONNECTION STEPS

Step 1: Velcro Straps

Step 2: Fix the bottom of the Comfort Base to the wooden slats of the bed frame with the Velcro straps.

Step 3: Fix two Velcro straps at the head of the bed frame.

Step 4: Fix two Velcro straps at the foot of the bed frame.



(4) Velcro Straps

Velcro Straps

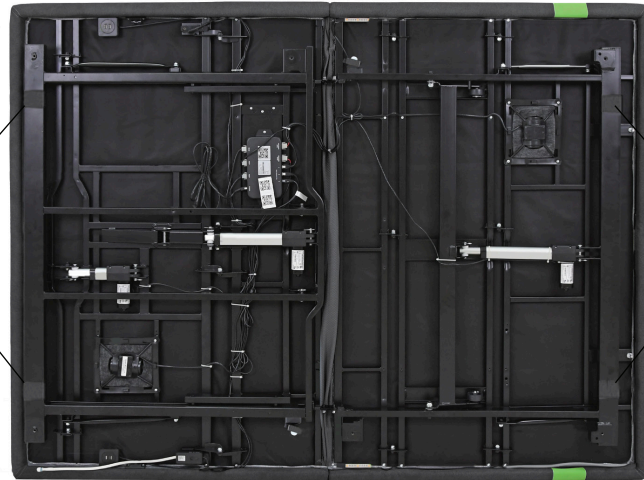

Velcro Straps

# CHILD SAFETY LOCK (OPTIONAL)

To lock movement of the adjustable base while using the remote, follow the instructions below.

- Step 1:** Double-click the “child lock” button on the back of the remote control. When the child icon on the screen turns to green, the child safety lock is on. The adjustable base will not respond when you press any button.
- Step 2:** Double click the “child lock” button again. The child icon on screen turns to grey when the child safety lock is turned off.



# REMOTE ASSEMBLY AND FREQUENCY SETUP

Locate the wireless remote control and insert (3x) AAA batteries (included). The remote control is pre-programmed to work with the adjustable bed base. If you have more than one adjustable bed base, each remote control and adjustable bed base set should be pre-programmed to work separately.

If the remote control is not communicating with the bed (the base is not responding by moving when the remote control is activated), please follow the below steps:

- Step 1: Check the batteries; replace if needed.
- Step 2: If the remote illuminates, unplug the power cord from the outlet.
- Step 3: Wait 5 seconds and plug it back into the outlet.
- Step 4: Wait 10 seconds after plugging the power cord into the outlet: Press the “head up” and “foot down” button at same time for 10 seconds; the adjustable base will be re-paired with the remote.

## FCC COMPLIANCE

This device complies with part 15 of the FCC Rules. Operation is subject to the following two conditions: (1) This device may not cause harmful interference and (2) this device must accept any interference received, including interference that may cause undesired operation.

To comply with the FCC RF exposure compliance requirements, no change to the antenna or the device is permitted. Any change to the antenna or the device could result in the device exceeding the RF exposure requirements and void user's authority to operate the device.

Radio Frequency: 2.4 GHz

# REMOTE CONTROL SYNCHRONIZING TWO ADJUSTABLE BASES

**Step 1:** Unplug base from power source.

**Step 2:** Connect the end of the simultaneous synchronization cable into the splitter for each control box. Use any open slot on the splitter.

Do not disconnect any other cords connected to the splitter; this will cause other features on the base to malfunction. Only one sync cord is needed.

**Step 3:** Plug base back into the power source.

**Step 4:** Check to ensure all cords are securely attached. Both remotes will now operate both bases simultaneously.

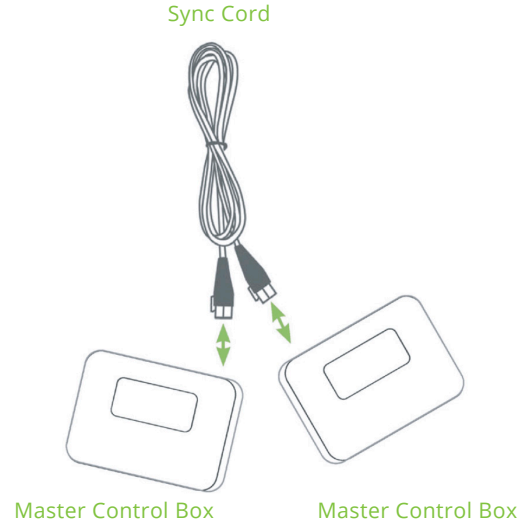

# REMOTE CONTROL FEATURES

**Programming Button I:** Get into desired adjustable base position, hold button for 5 seconds.

## BUTTON CYCLES

1x low / 2x mid / 3x high / 4x off

Anti-Snore returns to the flat position after five minutes.



# VOICE CONTROL INSTRUCTIONS

To operate your Comfort Base, use the voice invocation, Cariloha, and one of the command options shown here on this page.

For those with a Split King base who want to operate the sides of the base independently, ensure that one side's voice control box is set to "Cariloha" and the other side's voice control box is set to "Base". The same commands (shown below) will still apply – just say "Base" instead of "Cariloha" and vice versa.

## Motion Voice-Command Options

Invocation: "Hello Cariloha/Base" + Command

You have 3 seconds of articulation time to voice your command. Here are several motion voice commands that you can use:

### LIFT MOTORS

Raise Head

Raise Foot

Raise-Tilt

Lower Head

Lower Foot

Lower-Tilt

### PRESETS

Flat Preset

Anti-Snore

Lounge Preset

Favorite Preset

### FLAT

Good Night

### ZERO GRAVITY POSITION

Zero Gravity

Zero-G

Rise & Shine

### NIGHT LIGHT

Turn On Light

Turn Off Light

### EMERGENCY COMMANDS

Stop Running

All Up

## Message Voice-Command Options

Invocation: "Hello Cariloha/Base" + Command

You have 3 seconds of articulation time to voice your command. Here are several message voice commands that you can use:

### DUAL MESSAGE

Turn On Message

Turn Off Message

Message Up

Message Down

Stop Running (stops all motors)

### HEAD MESSAGE

Turn On Head Message

Turn Off Head Message

Head Message Up

Head Message Down

### FOOT MESSAGE

Turn On Foot Message

Turn Off Foot Message

Foot Message Up

Foot Message Down

### MESSAGE INTENSITY

Wave One

Wave Two

Wave Three



# FAQ

## Will the adjustable base fit inside my current bed frame?

Yes, we designed the adjustable base width and length to be ½" shorter than standard bed sizes to ensure the base fits within most bed frames. Even if you have a headboard and footboard with side rails and slats, our adjustable base will fit right in place.

## ADJUSTABLE BASE DIMENSIONS

Twin XL: 37.5"W x 79.5"L x 15"H

Queen: 59.5"W x 79.5"L x 15"H

Split King: (x2) 37.5"W x 79.5"L x 15"H

Cal King Split: (x2) 35.5"W x 83.5"L x 15"H

## What size of sheets do I buy for a King Split adjustable base?

Split King: Split King sheet set OR (2) Twin XL sheets

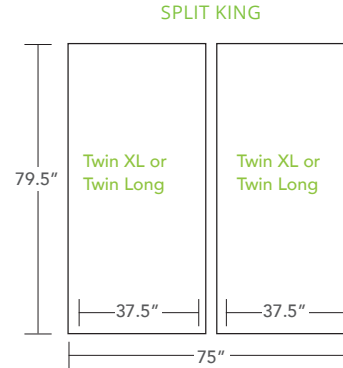

# TROUBLESHOOTING GUIDE

## IF ONE OR MORE FUNCTIONS ON THE BASE HAVE STOPPED OPERATING:

- Check under the bed base to verify that the wired connections are secure and that there are no cords or bedding obstructing the movement of the base.
- Check that the power cord is assembled properly and that the connections are secure.
- Check if green LED is on (power supply).

## IF THE LIGHTS ON YOUR REMOTE CONTROL NO LONGER ILLUMINATE AND WILL NOT OPERATE YOUR ADJUSTABLE BED BASE:

- Make sure the batteries are installed correctly.
- Install (3x) new AAA batteries in the remote control.

## IF ALL OF THE REMOTE CONTROL BUTTONS ILLUMINATE, HOWEVER NOTHING ON YOUR ADJUSTABLE BED BASE WILL OPERATE:

- Unplug the base for 5 minutes to reset the electronic components.
- Plug the adjustable base into a different electrical outlet, or test current outlet with another working appliance (a grounded, electrical surge protector is recommended).
- Complete the “Remote Assembly and Frequency Set Up” as the frequency on the bed may have been lost.

## IF THE HEAD OR FOOT MECHANISMS WILL ELEVATE BUT WILL NOT RETURN TO THE FLAT POSITION:

- Check the undercarriage for obstructions. Remove any obstructions away from the head and foot mechanisms and return the base to its flat position.

# COMPONENT GUIDE

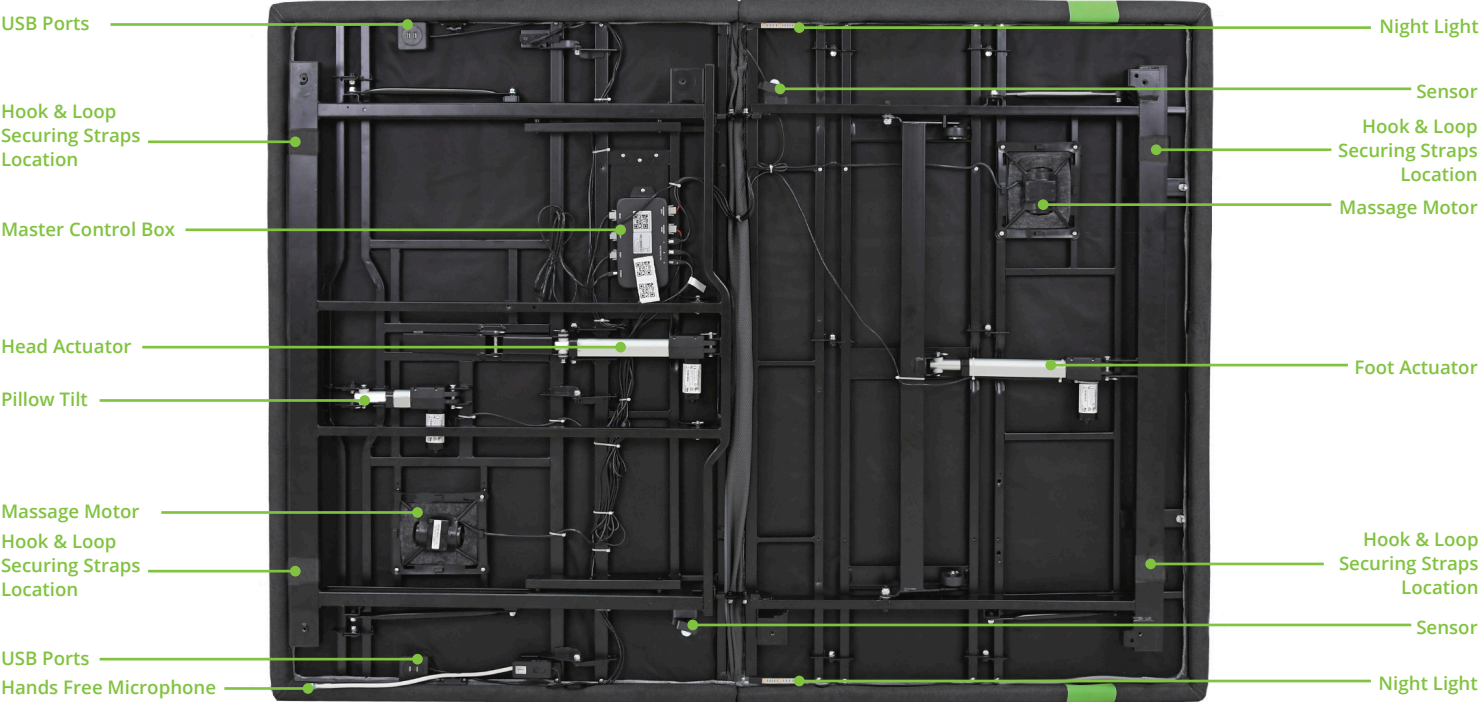

# RETREAT COMFORT BASE™ WARRANTY

## 1-YEAR FULL COVERAGE WARRANTY

The Cariloha Retreat Comfort Base is warranted against defects in materials or workmanship for a period of one year from the date of purchase to the original purchaser. During the first year, Cariloha will repair or replace, at no cost to the original purchaser, any defective part. This includes all authorized labor and transportation costs incurred with the repair or replacement of any parts found to be defective.

## 2-YEAR MOTOR WARRANTY

The Cariloha Retreat Comfort Base has a two-year, full-replacement warranty on parts, labor and transportation of the motor — should the motor(s) fail during the first two years of this warranty from the original purchase date.

## 10-YEAR LIMITED WARRANTY

Cariloha will replace, per the terms and conditions set forth in this paragraph, any bed part found to be defective. This warranty applies only to replacement part(s). Purchaser may be subject to charges for said part(s) to include, but not limited to, freight charges. Liability of Cariloha shall be limited to the replacement of the defective part(s) only. Purchaser is responsible for all service, installation and freight costs of said part(s).

## ADDITIONAL TERMS AND CONDITIONS

Warranty does not include reimbursement for inconvenience, removal, installation, set up, loss of use, shipping, or any other costs or expenses not expressly covered in this warranty.

This warranty does not apply:

- To damage resulting from misuse or abuse caused by the purchaser.
- To damage caused by the repairs or parts replacement by an authorized person.

- If the Cariloha Retreat Comfort Base has been mishandled (including during shipping), subject to physical abuse or an improper power supply, or otherwise operated in a manner inconsistent with procedures outlined in the owner's manual and warranty.
- To costs for unauthorized service calls for the purpose of educating the consumer about the Cariloha Retreat Comfort Base or locating properly functioning power outlets.
- If the recommended weight restrictions are exceeded.
- If used in any environment or a commercial setting for which it was not intended.

Some states do not allow the exclusion of incidental or consequential damages; therefore, the above limitation or exclusion may not apply. This warranty gives the purchaser specific legal rights. The purchaser may have other rights, which may vary from state to state. This warranty is valid in the 48 contiguous states.

## WORKING WEIGHT LIMITS

Although your bed has been rigorously tested within the recommended weight limits in this publication, to maintain the highest quality standards, exceeding the recommended weight limits may void your warranty. The recommended weight restriction is 750 lbs, and is calculated to include the weight of the mattress.

## CONTACT US

If you have any questions regarding this product or if you need assistance with set up and troubleshooting, please call Cariloha Customer Service: 800-884-5815.

You can find more information about Cariloha at [www.cariloha.com](http://www.cariloha.com).

CARILOHA 

*Cariloha, including all its appertaining names, logos, slogans, signage and taglines,  
are registered and trademarked by Cariloha, LLC.*

800-884-5815

[CARILOHA.COM](https://www.cariloha.com)